

SAFEasy TYPE 4 LIGHT CURTAINS

- **Integrated light curtains for FINGER PROTECTION**
- **Version with 14 mm resolution**
- **Special slot for device setting**
- **35 x 40 mm compact profile**

SE4 SERIES

The **SAFEasy**[™] light curtains, according to the IEC 61496-1 e IEC 61496-2 standards, are suitable for finger protection of operators exposed to risks.

Different models with six standard heights ranging from 150 to 900 mm, with 14 mm resolution and operating distance reaching 6 m are available.





Specific dip-switches, that can be reached through a slot present on the front of the receiver protected by a lid and opened with a simple screwdriver, guarantee rapid and safe device setting.

The operator is thus able to configure, according to the specific needs, the manual or automatic reset, as well as the muting and partial muting functions.

The emitter-receiver units are optically synchronised and contain all the control circuits, inputs and outputs inside the housing.

A wide range of industrial applications, requiring operator safety, can be solved by the **SAFEasy**[™] light curtains, thanks to the extremely compact dimensions (35x40 mm) and easy connection and installation.

TECHNICAL DATA

Power supply:	24 Vdc ± 20%, reverse polarity protection
Consumption:	70 mA max. (emitter) 65 mA max. (receiver without load)
Light emission:	infrared LED 880 nm
Optic diameter:	Ø 14 mm
Number of controlled beams:	<i>refer to table 1</i>
Optic interaxis:	7 mm
Resolution:	14 mm
Controlled height:	<i>refer to table 2</i>
Through beam operating distance:	0.2 ... 6 m
Receiver inputs:	external switches for Muting, Test, Start and Override
Receiver indicators:	green / red SAFE / BREAK LED 2 yellow ALIGNMENT LEDs green POWER ON LED
Emitter indicators:	yellow blinking FAILURE LED green POWER ON LED
Output type:	2 PNP
Output current:	0.7 A max. 0.25 A max. (45°C - 55°C) short-circuit signalling and protection
Response time:	<i>refer to table 3</i>
Selectable functions:	Muting / partial Muting Manual / Automatic reset <i>refer to table 4</i>
Receiver connection:	8-pole M12 connector
Emitter connection:	4-pole M12 connector
Safety category:	type 4
Electrical protection:	class 1
Mechanical protection:	IP65 IP67 (connector part)
Housing material:	aluminium with PC Makrolon plastic caps
Weight:	1.2 Kg max. / m of total height
Operating temperature:	-10 ... +55 °C
Storage temperature:	-25 ... +70 °C
Reference standards:	EN 954-1, IEC 61496-1, IEC 61496-2
Certifications:	   

TABLES

Model	Beams
SE4 height 150	21
SE4 height 300	42
SE4 height 450	63
SE4 height 600	84
SE4 height 750	105
SE4 height 900	126

Table 1: NUMBER OF BEAMS

Model	mm
SE4 height 150	161
SE4 height 300	308
SE4 height 450	455
SE4 height 600	602
SE4 height 750	749
SE4 height 900	896

Table 2: CONTROLLED HEIGHT

Model	ms
SE4 height 150	18
SE4 height 300	22
SE4 height 450	26
SE4 height 600	31
SE4 height 750	35
SE4 height 900	39

Table 3: RESPONSE TIME

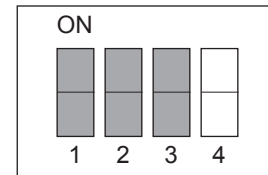

GREY dip-switches : Muting / partial Muting selection
WHITE dip-switches: manual / auto. reset selection

Table 4: DIP-SWITCH SELECTION

CONNECTIONS

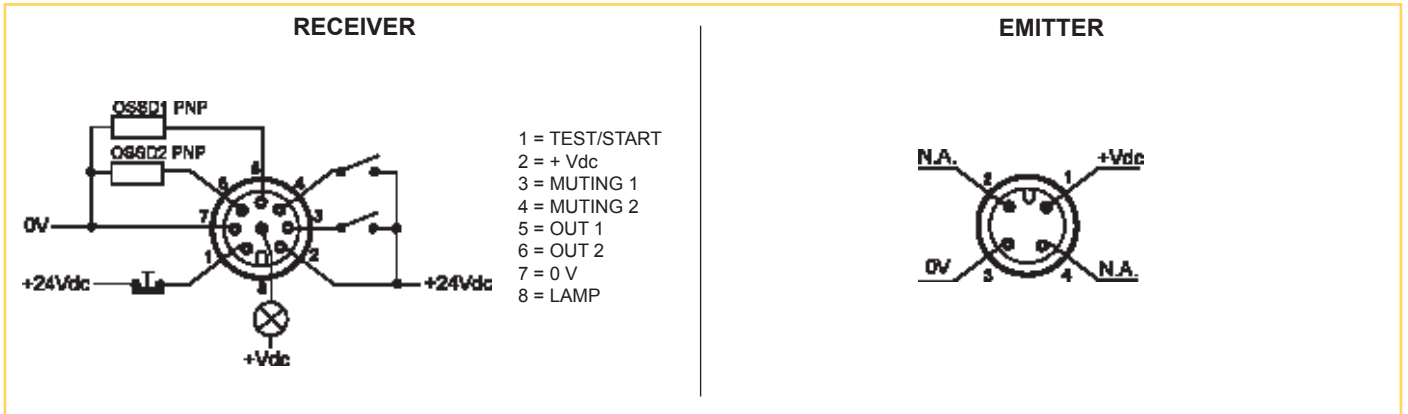

DIMENSIONS

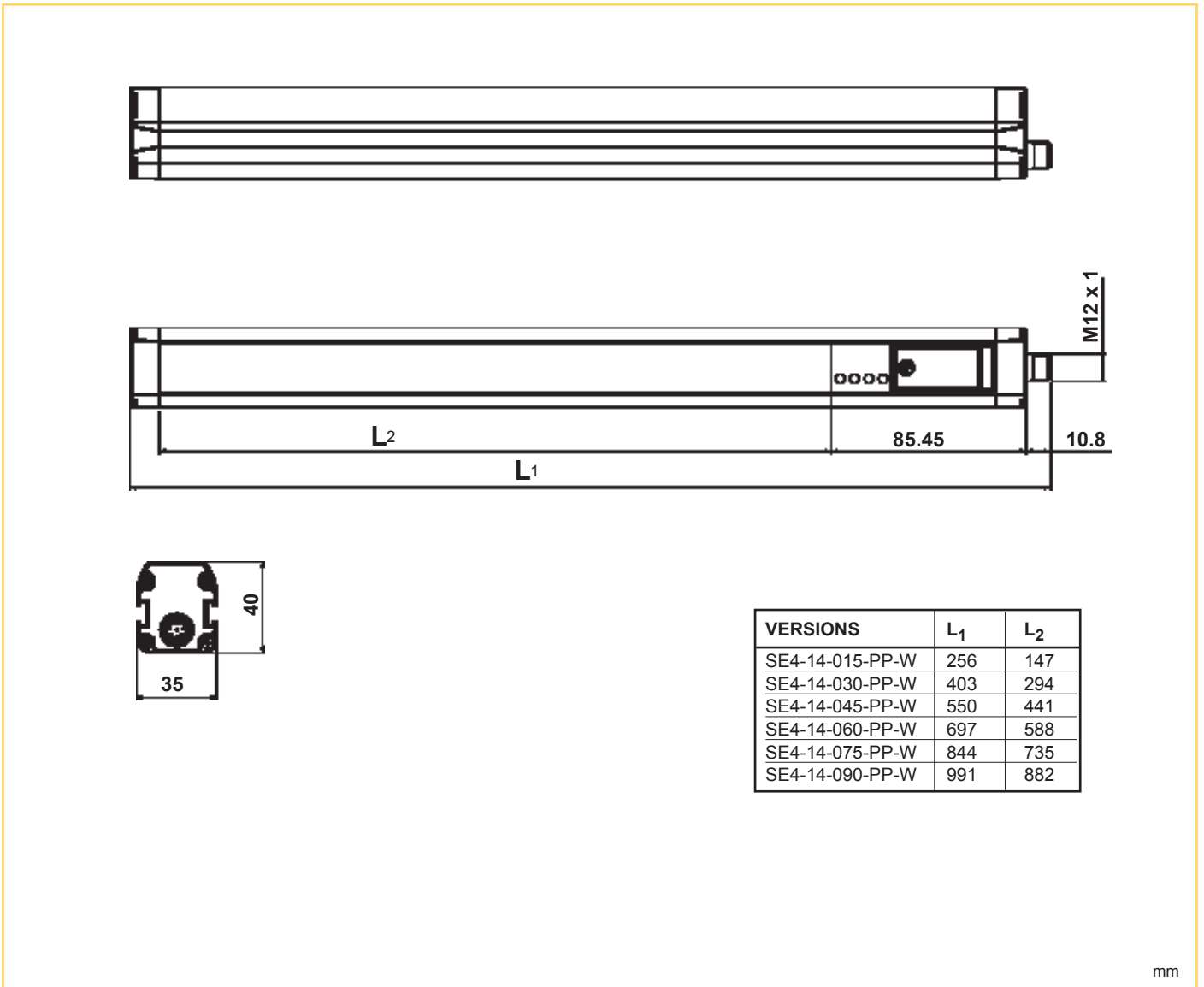



MODELS

MODEL	DESCRIPTION	CODE N°
SE4-14-015-PP-W	type 4 safety light curtain h=150 mm	957201150
SE4-14-030-PP-W	type 4 safety light curtain h=300 mm	957201160
SE4-14-045-PP-W	type 4 safety light curtain h=450 mm	957201170
SE4-14-060-PP-W	type 4 safety light curtain h=600 mm	957201180
SE4-14-075-PP-W	type 4 safety light curtain h=750 mm	957201190
SE4-14-090-PP-W	type 4 safety light curtain h=900 mm	957201370

ACCESSORIES

*Please refer also to **Safety Device Accessories***

Note: All the accessories have to be ordered separately

Distributed by:

HEADQUARTERS

DATASENSOR SpA

via Lavino, 265 - 40050 Monte San Pietro, BO - Italy
Tel. +39 051/6765611 • Fax +39 051/6759324
www.datasensor.com • e-mail info@datasensor.com

Datasensor SpA endeavours to continuously improve and renew its products; for this reason the technical data and contents of this catalogue may undergo variations without prior notice. For correct installation and use Datasensor SpA can guarantee only the data indicated in the instruction manual supplied with the products.